

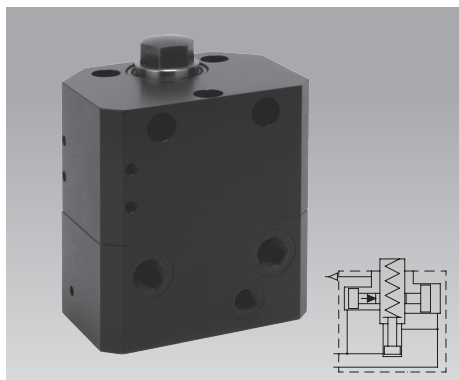

## Work Support, Self-Locking

with pneumatic position monitoring, 3 sizes, 2 types of function, double acting, max. operating pressure 500/400 bar



### Application

Hydraulic work supports are used to provide a self-adjusting rest for the workpiece during the machining operations. They compensate the workpiece surface irregularities, also vibration and deflection under machining loads.

Hydraulic locking is made together with hydraulic clamping of the workpiece, or independently.

Due to the self-locking function of the support plunger, these work supports are particularly suitable for:

- Manufacturing systems with pallet store
- Clamping fixtures with workpiece loading via handling systems
- Transfer lines
- Automatic manufacturing systems
- Assembly lines
- Indexing machines
- Special machine tools

### Important notes

If there is any danger of fluids being sucked into the filter, a vent hose has to be connected at the venting port.

The standard contact bolt in the support plunger protects the interior against contamination. For the use of self-manufactured contact bolts please consider the installation dimensions (see page 4).

For unlocking of the support plunger the same pressure as for clamping is required.

Support and clamping forces have to be adapted to each other, so that there will be sufficient force reserve available for the work support to absorb the machining forces (see page 4).

The self-locking is not positive. The introduction of vibrating machining forces has to be avoided. Admissible load force see diagrams (page 2 and 3).

Operating conditions, tolerances and other data see data sheet A 0.100.

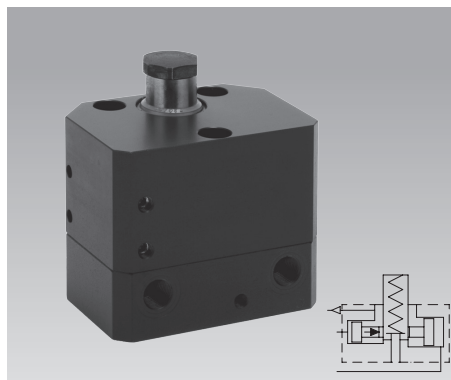

### Function

For the plunger contact at the workpiece there are two variants:

#### 1. Off-position extended

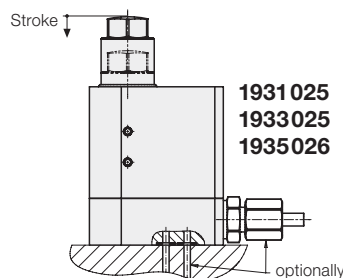

When loading the fixture, the support plunger is pushed back by the workpiece and contacts the workpiece by spring force. Then hydraulic locking can be effected. During unclamping the support plunger will be unlocked and moved forward by a little spring force when unloading the workpiece.

**Advantage:** Compact design.

#### 2. Off-position retracted

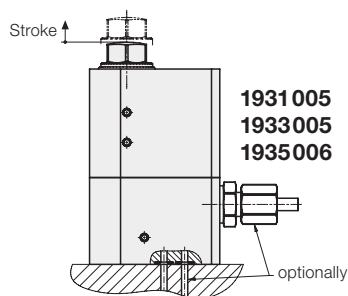

When pressurising the element, the support plunger moves forward with a light spring force against the workpiece. Then locking is automatically effected.

**Advantage:** Unimpeded loading and unloading of the clamping fixture!

### Advantages

- No yielding at the workpiece, even if pressure drops, due to patented locking with self-locking function.
- Very little elasticity of the support plunger.
- No axial displacement of the support plunger during locking.
- Compensation of side loads, if a clamping element clamps directly onto the workpiece (see application example).
- Optimum adaptation to the workpiece due to asymmetrical shape of the body.
- Little contact force to the workpiece due to spring force.
- Oil supply optionally via fittings or drilled channels
- High process safety due to integrated pneumatic position control as well as hydraulic retraction of the support plunger (193X00X)
- Mounting position: any
- Standard FKM seals

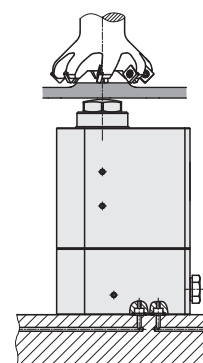

### Application example

Manifold-mounted work support with swing clamp 1893 102 as per data sheet B 1.8803.

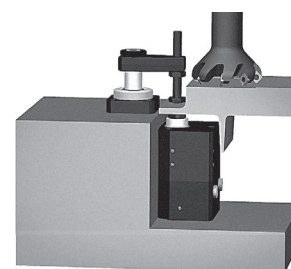

Dimensioning see page 4.

**Type of function: Spring force**  
**Off-position extended • Contact by spring force**

**Function**

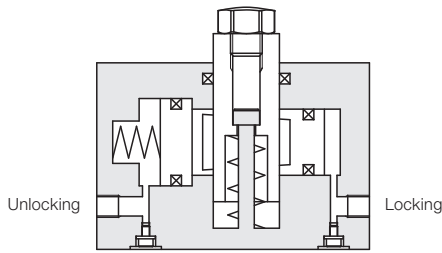

**Clamping**

The support plunger is pushed back by the inserted workpiece, the spring force has to be overcome.

Due to the hydraulic pressure the wedge surface of the cross piston is moved against the support plunger and thereby the support plunger is locked.

**Unclamping**

For unlocking of the support plunger the same pressure as for clamping is required. The support plunger contacts the workpiece until it is taken out of the fixture.

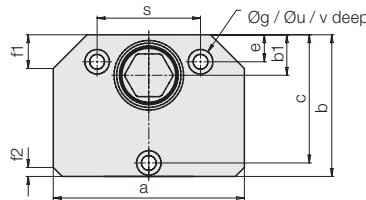
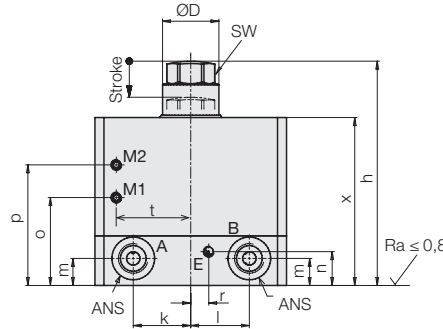
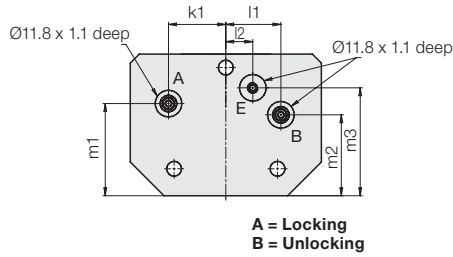

**Notes:**

**1. Manifold-mounting**

For manifold mounting remove screw with sealing (see bottom) and insert O-ring 9x1.5 (Part no. 3001305) into the counterbore.

Connecting hole max. Ø 7 mm. Screw in plug G 1/4 or G 1/8 (Part no. 3610264 or 3610263).

**2. Pneumatic position monitoring**

To operate the position monitoring, remove the set screws (M5) and screw in insertion nipple fitting (Part no. 3890091) or L-type insertion nipple fitting (Part no. 3890094).

M1 – support plunger retracted, thread M5.

M2 – support plunger extended, thread M5.

E – do not close venting port, thread M5 (see important notes).

**Admissible load force as a function of the operating pressure**

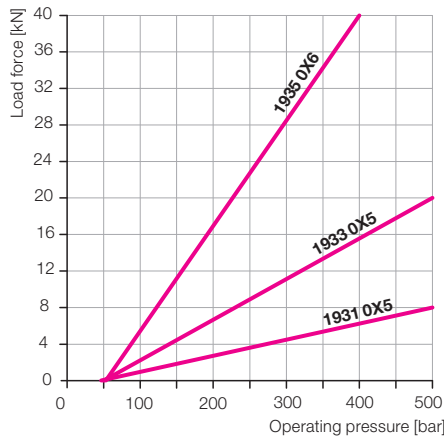

Max. operating pressure	[bar]	500	500	400
Load force at 500/400 bar	[kN]	8	20	40
Support plunger ØD	[mm]	16	25	40
Stroke of support plunger	[mm]	8	12	20
a	[mm]	70	85	140
Port		G1/8	G1/4	G1/4
b	[mm]	48	63	105
b1	[mm]	13	18	36
c	[mm]	42	57	95
e	[mm]	6	12	16
f1 x 45°	[mm]	10	15	22
f2 x 45°	[mm]	4	4	4
g	[mm]	5,5	6,6	10,5
h	[mm]	76,5	99,5	156,5
k	[mm]	22	25,5	44
k1	[mm]	22	25,5	44
l	[mm]	22	26	44
l1	[mm]	20	24,5	49
l2	[mm]	0	12,0	15
m	[mm]	14	12	15
m1	[mm]	36	41	65
m2	[mm]	22	36	44
m3	[mm]	31,5	48	80
n	[mm]	7	15	15
o	[mm]	28,5	38	58,6
p	[mm]	43	53,5	85,5
r	[mm]	6	9	15
s	[mm]	36	46	80
t	[mm]	26	33	60
u	[mm]	10	11	18
v	[mm]	11	15	27
x	[mm]	60	74,5	120
SW	[mm]	17	19	30
Contact/spring force	[N]	15 up to 22	23 up to 50	55 up to 110
Recommended minimum pressure	[bar]	100	100	100
Max. oil volume stroke / locking	[cm³]	0,2	4,9	7,5
Max. oil volume return stroke	[cm³]	0,3	8,4	11,7
Max. flow rate	[cm³/s]	25	25	25
Max. elastic deformation during load	[µm/kN]	0,7	1,5	1
Weight	[kg]	1,4	2,8	12,5
<b>Part no.</b>		<b>1931025</b>	<b>1933025</b>	<b>1935026</b>
<b>Accessories</b> (not included in the delivery)				
<b>Part no.</b> O-ring (FKM) 9 x 1,5		<b>3001305</b>	<b>3001305</b>	<b>3001305</b>
<b>Part no.</b> plug		<b>3610263</b>	<b>3610264</b>	<b>3610264</b>

## Type of function: Hydraulic pressure and spring advanced Extending hydraulically • Contact by spring force

### Function

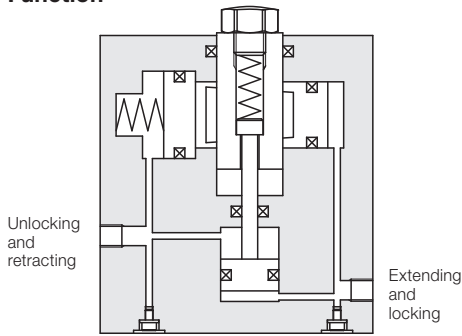

### Clamping

The support plunger is extended by a small piston and contacts the workpiece with spring force.

Due to the increasing hydraulic pressure the wedge surface of the cross piston is moved against the support plunger and thereby the support plunger is locked.

### Unclamping

For unlocking of the support plunger the same pressure as for clamping is required. At the same time the small piston is retracted by hydraulic pressure and takes the support plunger along.

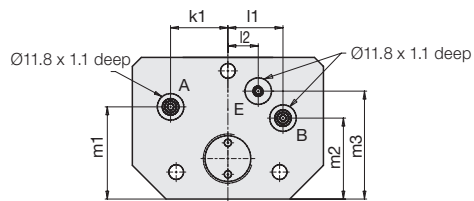

A = Extending and locking  
B = Unlocking and retracting

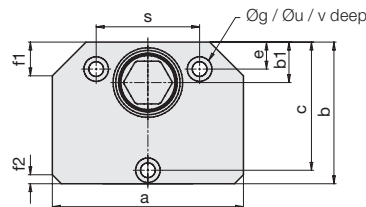
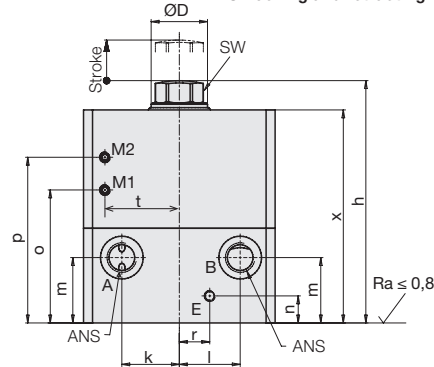

### Notes:

#### 1. Manifold-mounting

For manifold mounting remove screw with sealing (see bottom) and insert O-ring 9x1.5 (Part no. 3001305) into the counterbore.

Connecting hole max. Ø 7 mm. Screw in plug G 1/4 or G 1/8 (Part no. 3610264 or 3610263).

#### 2. Pneumatic position monitoring

To operate the position monitoring, remove the set screws (M5) and screw in insertion nipple fitting (Part no. 3890091) or L-type insertion nipple fitting (Part no. 3890094).

M1 – support plunger retracted, thread M5.

M2 – support plunger extended, thread M5.

E – do not close venting port, thread M5 (see important notes).

### Admissible load force as a function of the operating pressure

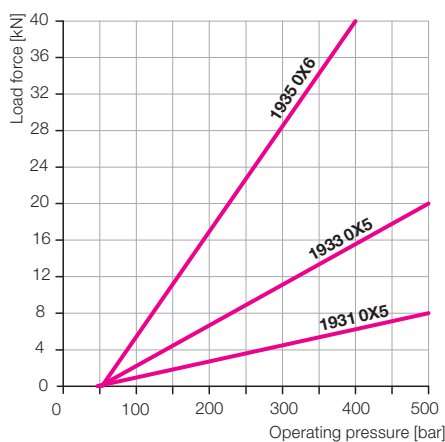

Max. operating pressure	[bar]	500	500	400
Load force at 500/400 bar	[kN]	8	20	40
Support plunger ØD	[mm]	16	25	40
Stroke of support plunger	[mm]	8	12	20
a	[mm]	70	85	140
Anschluss		G1/8	G1/4	G1/4
b	[mm]	48	63	105
b1	[mm]	13	18	36
c	[mm]	42	57	95
e	[mm]	6	12	16
f1 x 45°	[mm]	10	15	22
f2 x 45°	[mm]	4	4	4
g	[mm]	5,5	6,6	10,5
h	[mm]	86,5	107,5	163,5
k	[mm]	22	25,5	44
k1	[mm]	22	25,5	44
l	[mm]	22	27	44
l1	[mm]	20	24,5	49
l2	[mm]	0	13,5	15
m	[mm]	30	29	20
m1	[mm]	36	41	65
m2	[mm]	22	36	44
m3	[mm]	31,5	48	80
n	[mm]	15	12	35
o	[mm]	46,5	58	85,6
p	[mm]	61	73,5	112,5
r	[mm]	14,5	13,5	15
s	[mm]	36	46	80
t	[mm]	26	33	60
u	[mm]	10	11	18
v	[mm]	11	15	27
x	[mm]	78	94,5	147
SW	[mm]	17	19	30
Contact/spring force	[N]	15 up to 22	23 up to 50	55 up to 110
Recommended minimum pressure	[bar]	100	100	100
Max. oil volume stroke / locking	[cm³]	1,8	7,3	11,5
Max. oil volume return stroke	[cm³]	1,6	9,5	14,2
Max. flow rate	[cm³/s]	25	25	25
Max. elastic deformations				
during load	[µm/kN]	0,7	1,5	1
Weight	[kg]	1,8	3,5	15,5
<b>Part no.</b>		<b>1931005</b>	<b>1933005</b>	<b>1935006</b>
<b>Accessories</b> (not included in the delivery)				
<b>Part no.</b> O-ring (FKM) 9x1.5		<b>3001305</b>	<b>3001305</b>	<b>3001305</b>
<b>Part no.</b> plug		<b>3610263</b>	<b>3610264</b>	<b>3610264</b>

# Combination with clamping elements Control / position monitoring • Self-manufactured contact bolts

## Combinations of work supports with swing clamps of the same size

The admissible load force of work supports has always to be dimensioned so that the clamping force of the used clamping elements and the static and dynamic machining forces can be safely compensated.

- Admissible load force**
- **Clamping force**
- **Safety (reserve)**
- 
- = **Possible machining force**

On principle the load force of the work supports should be at least twice the clamping force of the clamping elements.

### Load force $\geq 2 \times$ clamping force

If the total of all occurring forces exceeds the admissible load force, the support plunger of the work support will be pushed back and the work support will be damaged.

For combinations of work supports with swing clamps (see example), this condition should be met at 200 bar.

For the smallest size 1931 there is no suitable swing clamp available. With the swing clamp 1891XXX the operating pressure would have to amount to 500 bar! For both larger work supports, there are suitable swing clamps as shown in the below charts.

The vertical distance of the two straight lines in the area of the colorised surface indicates the resulting maximally possible machining force including reserve.

### Size 1933

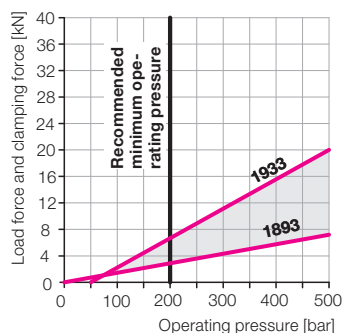

### Size 1935

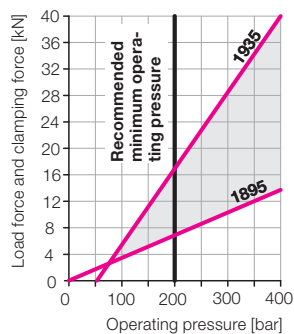

### Important note

The admissible load forces as per the diagram are static. The machining forces can also generate vibrations which exceed by far the mean value. For this reason a corresponding safety factor has to be taken into account.

### Example

The swing clamp 1893104 (data sheet B 1.881) clamps a workpiece onto the work support 1933005.

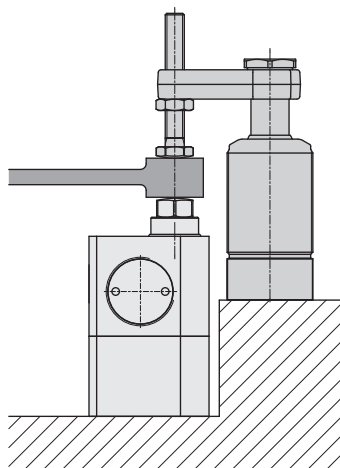

For size 1933 the following can be taken from the diagram:

Minimum operating pressure: 200 bar  
Load force at 200 bar: 6,6 kN  
Clamping force at 200 bar: 2,8 kN

Possible machining force at 200 bar:

Admissible load force: 6,6 kN  
- Clamping force: - 2,8 kN  

---

= Possible machining force: 3,8 kN  
(including reserve)

### Pneumatic position monitoring

With the pneumatic position monitoring the following messages can be realised:

- M1 – support plunger retracted
- M2 – support plunger within the useable working area

### Function chart

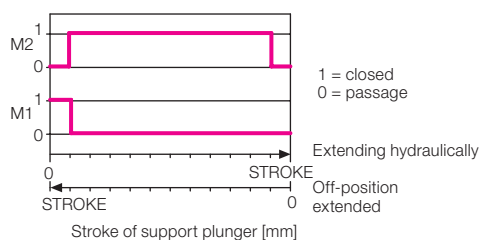

For process-safe functioning of the position monitoring, air pressure and air volume must be adapted.

Nominal values: Air pressure 2.5 bar  
Flow rate 12 l/min

The measurable differential pressure depends on jet diameter, leakage, pressure, flow rate and pipe length. It should be approx. 1.8 bar.

For the interpretation, we recommend a pneumatic differential pressure switch, which can monitor up to 8 work supports. Also pneumatic pressure switches can be used. According to the number of the connected work supports, air pressure or flow rate have to be adapted possibly.

### Control of clamping sequence

The sequence – supporting and clamping – has to be controlled as a function of the pressure, e.g. by a sequence valve.

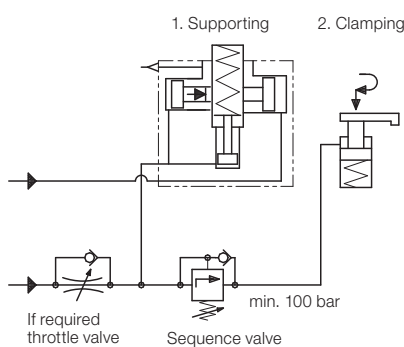

The sequence valve has to be adjusted to an opening pressure above the intersection of the two straight lines in the diagram.

If due to a too high flow rate a throttle valve is required, installation should be made as shown in the hydraulic circuit diagram.

### Required dimensions for self-made contact bolts

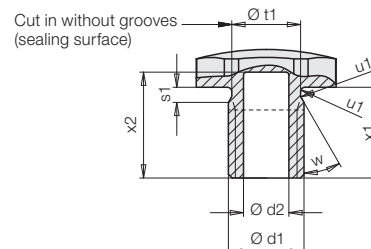

Work support	1931	1933	1935
Ød1	M10	M12	M20
Ød2	6	-	-
x1	12	9	12
x2	14	-	-
s1	2	3	4
t1	9,1 ± 0,05	9,4 ± 0,05	16,5 ± 0,05
u1	R0,6	R0,4	R0,6
w	30°	39 to 60°	39 to 60°
O-ring	9x1	9x2	15,54x2,62
<b>Part no.</b>	<b>3001674</b>	<b>3001869</b>	<b>3000103</b>